

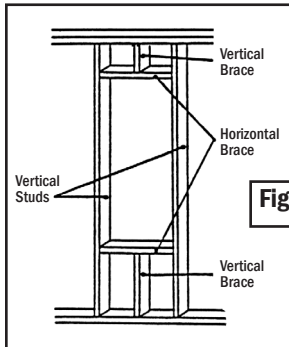

FOCAL POINT

The Art of Architecture™

NICHE "A" INSTALLATION (1 OF 2)



Instructions for Gainsborough 91000 & 91350 (with pilasters) and Regency 91200 & 91300 (with casing)

Please Read And Follow All Installation Instructions Carefully

1. Framing

- The Gainsborough requires framing out from or into a new or existing wall.
- Refer to rough opening dimensions and install (*figure 1*):
 - vertical studs
 - horizontal braces
 - vertical braces

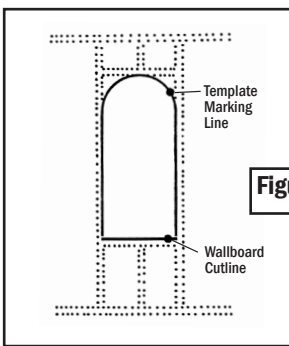

2. Wall Prep

- Install wallboard.
- Mark locations of studs and braces on wallboard.
- Mark wallboard along line just above bottom horizontal brace between studs. (*figure 2*)

3. Cutting Wallboard

- Using face of niche as a template, trace cutline on wall, position bottom to rest on horizontal brace. Then cut wallboard. (*figure 2*)

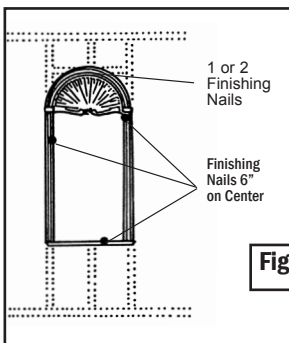

4. Niche Installation

- Place niche into rough opening, with bottom resting on horizontal brace.
- **Important** – Niche face should be flush with face of wallboard and checked for level/plumb.
- Screw or nail into bracing and studs. (*figure 3*)

5. Shelf Installation

- Apply adhesive to back of shelf bracket; position shelf level to bottom of niche and center.
- Toenail or screw into horizontal brace. (*figure 4*)

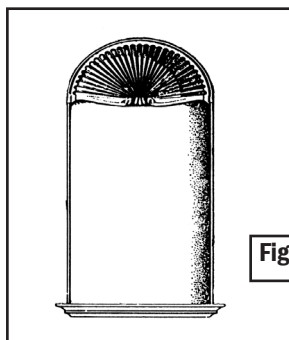

6a. Rim and Casing Installation

- Don't cut plinths off rim.
- Center rim over niche; leaving scallops of niche exposed.
- Check level of rim; if not level, pull out or push in sides of rim.
- Screw or nail into place.
- Measure distance between rim and shelf bracket, cut casing to fit.
- Level/plumb casing and nail in place.



FOCAL POINT

The Art of Architecture™

NICHE "A" INSTALLATION (2 OF 2)

Please Read And Follow All Installation Instructions Carefully

6b. Rim and Pilaster Installation

- Cut plinths off rim.
- Center rim over niche; leaving scallops of niche exposed.
- Check level of rim; if not level, pull out or push in sides of rim.
- Screw or nail into place.
- Measure distance between rim and shelf bracket, trim pilaster from bottom if required.
- Level/plumb casing and nail in place. (figure 5)

7. Finishing

- Countersink all nails and screws then spackle.
- Caulk between elements and wall.
- Spackle and/or Bondo between shelf bracket and niche.
- Sand and reprime if needed.
- Paint with high quality latex or oil-based paint.
- **Do Not** use lacquer-based paints.

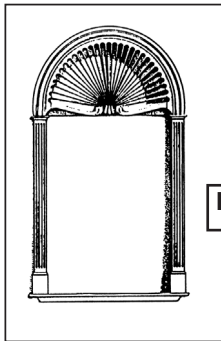
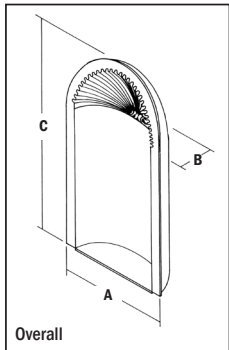
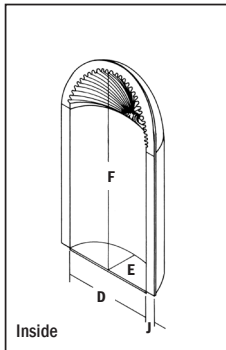

Figure 5



Overall



Inside

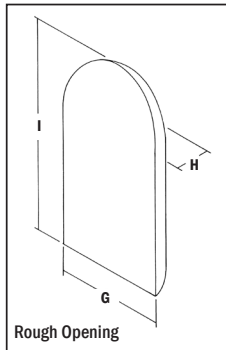

Rough Opening

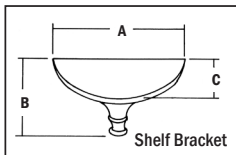

Shelf Bracket

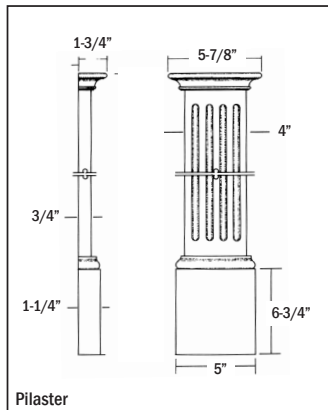

Pilaster

Niche Unit Sets		91000	91350	
Niche Unit	Overall	Width A	27-1/4"	32-7/8"
		Depth B	9"	9-7/8"
		Height C	56"	58-1/2"
	Inside	Width D	25-1/2"	31"
		Depth E	7-3/4"	9"
		Height F	53-5/8"	56-1/2"
	Rough Opening	Width G	28"	33-1/2"
		Depth H	9-1/4"	10-1/2"
		Height I	56-1/2"	59-1/2"
Pilaster	See Illustration	Width J	5-7/8"	5-7/8"
		Proj K	1-3/4"	1-3/4"
Niche Rim	Overall	Width	32-5/8"	37"
		Height	17-1/2"	19-1/8"
	Inside	Width	25-3/4"	30"
		Height	14"	15-5/8"
Shelf Bracket	Overall	Width A	34-3/4"	41"
		Height B	3-1/8"	3-1/4"
		Proj C	3-1/8"	3-1/8"